



# Championship Elite Start System

## User Instructions



**Colorado  
TIME SYSTEMS**

A **PLAYCORE** Company  
F1064 Rev 202411

Colorado Time Systems

Corporate Office  
1551 East 11th Street  
Loveland, CO 80537 USA

Sales: 1-800-279-0111 or +1 970-667-1000

Service: 1-800-287-0653 or +1 970-667-1000  
FAX: +1 970-667-1032

Web: [www.coloradotime.com](http://www.coloradotime.com)  
Email: [support@coloradotime.com](mailto:support@coloradotime.com)

Information in this manual is subject to change without notice. Pictures and illustrations may not accurately depict your version. Please check our website for the most current information; our user manuals are available online in the customer service section of our website.

This device complies with Part 15 of the FCC Rules. Operation is subject to the following two conditions:

1. This device may not cause harmful interference.
2. This device must accept any interference received, including interference that may cause undesired operation.

Unauthorized modifications or changes made to this device not expressly approved by the party responsible for compliance will void the user's authority to operate the equipment.

# Table of Contents

Introduction .....	5
Installation and Maintenance .....	5
Location	
Mounting Options	
Features .....	6
Control Panel and Connections .....	7
Power Button .....	7
Status Indicator .....	7
Boot up	
Ready to Start Mode	
Visual start sequence	
Start and Recall	
Charging	
Navigation Controls .....	8
Lane Speaker Connection .....	8
External Visual Indicator / Speedlight connection .....	8
External Visual Indicator (EVI) and EXTSTROBE+	
Speedlight Connection	
Start Connection .....	9
Charging Port .....	10
Microphone Connection .....	10
VSS Connection .....	10
Wallplate Connection .....	10
Visual Start Signaling (VSS) .....	11
Functionality with two officials .....	11
Functionality with one official .....	12
Forward Start Signaling Overview .....	13
Backstroke Start Signaling Overview .....	14
Operation .....	15
Main Screen .....	15
Navigation .....	15
Battery .....	16
Championship Elite and Electronic Timer .....	16
Starter's Microphone .....	17
Optimize Microphone Operation	
Training Mode .....	17
Strobe Usages: Internal and EVIs/EXTSTROBE+s .....	18
Settings .....	19
Navigation .....	19
Main Menu .....	19
Audio Settings .....	19
Start Settings .....	20
Start Volume	
Configure EVIs	
Start Tone	
Recall Tone	
Recall Time	
EVI and EXTSTROBE+ Configuration .....	21
Strobe Intensity	
Lane Indicator Intensity	

Reset All to Lane Indicators #1 through #13	
Training Mode Settings .....	22
Start Training	
Interval setting	
Use VSS	
TYM (Take Your Marks)	
Record Custom TYM	
System/Advanced Settings .....	23
Auto Off	
Backlight Brightness	
Backlight Time	
Advanced Options	
Serial Number	
Advanced Options .....	24
Internal Strobe Intensity	
Start Signal Polarity	
Contrast	
Restore Defaults	
Maintenance .....	25
Batteries	
Storage	
Configuration Diagrams: .....	26
Connection to Legacy Wallplate:	
Connection to Gen7 In-Deck or Wallplate:	
Connection to Deckplate, Cable harness, or Timer:	
Troubleshooting .....	28
Specifications .....	30
Appendix A: Certifications .....	31
Safety Certification .....	31
Appendix B: Factory Default Settings.....	33
Appendix C: Supporting & Auxiliary Equipment.....	35

## Introduction

Thank you for purchasing Colorado Time Systems' Championship Elite electronic start system. Its multi-purpose design makes the Championship Elite starter perfect for use as an electronic start system or a limited public address system. The Championship Elite Start System contains many features including multiple start tones, programable start messages, training mode, integrated Visual Start Signal (VSS), and ultra-bright adjustable LED strobes. The ability to be used as a limited public address system allows announcements to be made to athletes during practice and to athletes and spectators during a meet.

## Installation and Maintenance

The Championship Elite Start System is designed for use in indoor or outdoor swimming pool environments. When operated in the United States, it must be used in accordance with the National Electric Code. When operated outside of the United States compliance with all applicable national and local codes and regulations is required.

The Championship Elite starter's charging power supply must be used indoors with a grounded outlet and is intended to be connected to a circuit protected by a ground-fault circuit interrupter (GFCI) when charging.

Using the Championship Elite Start System in a manner not specified by Colorado Time Systems may cause the protection provided by the equipment to be impaired. Other than maintenance items described in this manual, there are no user serviceable parts on the Championship Elite Start System. When replacing parts, use only replacement parts specified and only perform service while the unit is powered off and disconnected from power.

## Location

Select an appropriate location for your start system.

Important: When installing the start system in a pool area, always place the start system in a location where there is no chance that it could fall into the pool.

When using the built-in strobe light, the start system should be positioned so that officials can start their watches from the strobe rather than the start tone, improving the accuracy of watch starts.

When using external visual indicators (EVIs) and EXSTROBE+s, position the EVIs and EXSTTROBE+s functioning as lane indicators so that they are visible to athletes from both the starting blocks and in the water during backstroke starts. Place the EVIs and EXSTTROBE+s functioning as strobes away from athletes to not impair their vision and where they can be easily seen by officials so that they can start their watches from the strobe rather than the start tone, improving the accuracy of watch starts. Please see page 8 for details about External Visual Indicators.

## Mounting Options

Place the Championship Elite starter on a tabletop, or use the optional CTS tripod (TR-3) or flagpole mount (START-FPM-2) with its mounting bracket. Use the tripod or flagpole mount to gain greater freedom to place the Championship Elite starter in the most convenient location.

## Features

The Championship Elite electronic start system contains many advanced features which make it versatile and easy to adapt to every application.

- 0.25 second dual tone electronic blast with simultaneous flash on 360° internal strobe
- Support for up to 12 External Lane Speakers.
- External Visual Indicators (EVIs) and EXTSTROBE+s can be connected and set to function as additional external strobes (2 EVIs or EXSTTROBE+s in the sequence can be set as a strobe) or set to function as lane indicators for the Visual Start Sequence.
- The system can also be used as a public address system to address swimmers and spectators.
- The start and recall tones can be set to either the classic CTS beep or an alternate beep.
- The intensity of the strobe and EVIs/EXTSTROBE+s and the loudness of the tones can be set to outdoor, indoor, or office levels (e.g. for starters installed in offices or for operator training).
- The polarity of the start signal can be set to normally open or normally closed.
- A training mode is available that provides a recorded “Take your marks” message and start signaling with a variable interval between starts.
- The Championship Elite is set to automatically shut off when not in use. The amount of time that the starter will remain idle before shutting down can be chosen in the system options.
- The system features a bright, outdoor usable LCD screen that provides easy menu navigation.
- Internal 12V Gel-cell Batteries.
- Intelligent charging system for fast recharge and battery maintenance.

Various sections of this manual contain QR codes linked to accompanying tutorial videos. Click or scan the QR codes to see the Championship Elite Start System in action.



Sample

# Control Panel and Connections

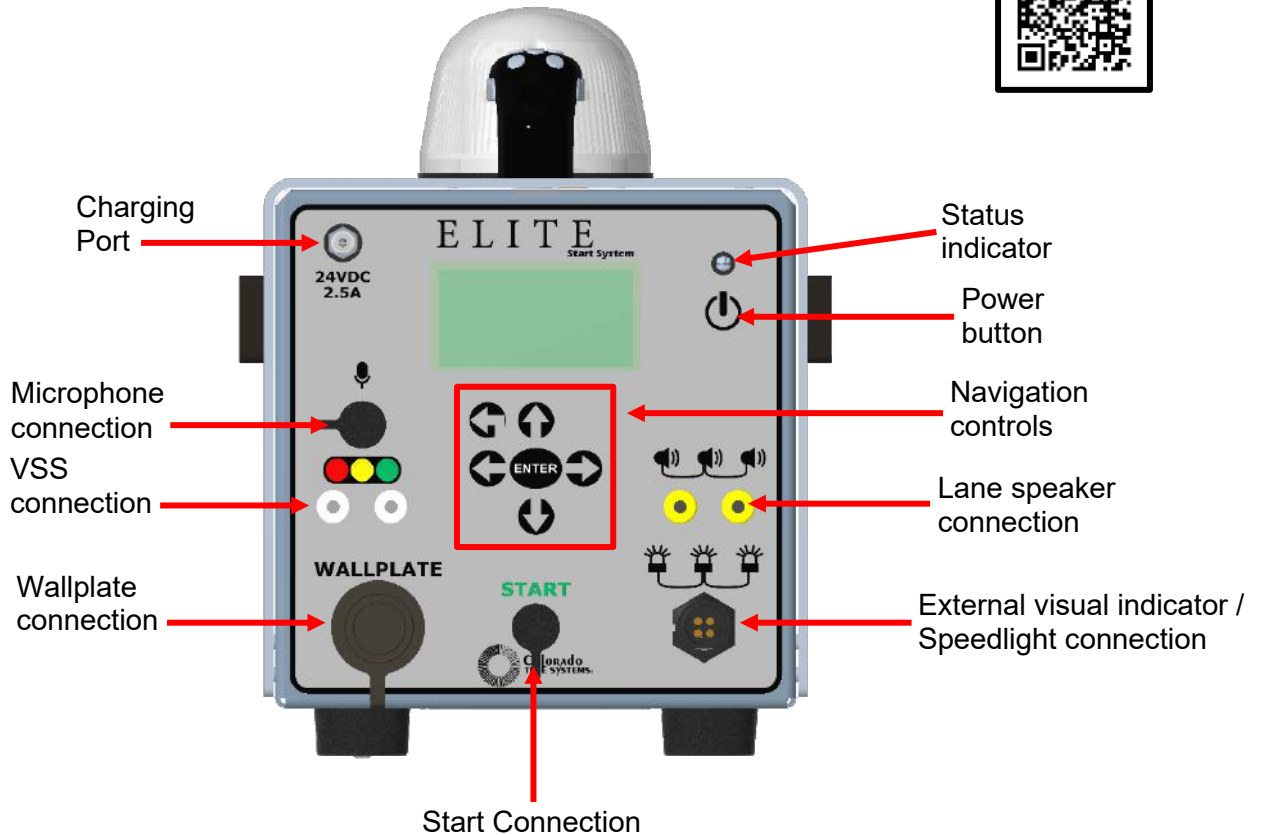

## Power Button

Press the power button for about 3 seconds to turn the unit on. Press and hold the power button for approximately 5 seconds to power the unit off.

Regardless of start or PA operation, the Championship Elite starter consumes power whenever it is turned on. Turn the unit off to conserve battery power while not in use.

The device features a self-shut down option. If no buttons are activated for a settable time of 15, 30, 45, 60, 75 or 90 minutes the unit will shut itself down to preserve battery charge.

Press the power button twice in quick succession to display context help screens for the main screen or sub menu currently selected.

## Status Indicator

### Boot up

The status indicator LED lights up in a red, green, blue, then green sequence during the boot up cycle when the unit is powered on.

### Ready to Start Mode

When the unit is in the ready to start state, the status LED will display the battery's state of charge.

- Green = 100% - 50% charge
- Blinking Green = 50% - 30% charge
- Blinking yellow = 30% - 10% charge
- Blinking Red = 10% - 0% charge

When the battery indicator is blinking red, the device will shut itself down without warning after 20 minutes to preserve the battery.

When the microphone is not connected, the status LED will blink yellow.

## Visual start sequence

When VSS sequence is used, the light pattern will be presented on the internal strobe as well as all connected EVIs and EXTSTROBE+s.

## Start and Recall

When a start is initiated the status LED will flash white and will then rapidly blink white during the recall period. The recall period is set to 15 seconds at the factory but can be set at 5 second increments between 5 and 25 seconds. Pressing the start button during this time will activate the recall tone.

## Charging

The status LED will slowly ramp up in green when the unit is plugged in and charging and will blink a long blink when the battery is fully charged. Once the battery is fully charged and still plugged in, the device will stay in maintenance mode to maintain the battery charging level over time. The LCD provides charging status information as well.

If the battery is found to be deteriorated and sulfated, the charging system charges it slowly to regenerate the battery. During that time the charging pattern is yellow.

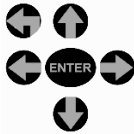

## Navigation Controls

The menu navigation controls are used to navigate the menus of the Championship Elite starter. See page 19 for detailed information about menu options.

## Lane Speaker Connection

Here is where additional external speakers can be connected to the Championship Elite starter in addition to the built in 40-watt, 8-ohm moisture and corrosion resistant reflex speaker. The Championship Elite supports up to 12 additional 45 Ohm lane speakers (R-SP-6-45) or up to two 8 Ohm external speakers (R-SP-125 or R-SP-200) or two underwater speakers (SP-UND). Connect each speaker to its associated deck plate or cable harness, which is connected to the main **Lane Speaker** connector on the Control Panel.

Alternately use the Wallplate CMP connection with a CMP-WPxx cable to legacy wallplates or a Gen7 TDPI-S2 cable (R-015-706-x) to connect to lane speaker connections in the deck. Note: a Gen7 TDPI-S2 cable (R-015-706-x) also connects the start signal to the deck.

## External Visual Indicator / Speedlight connection

This is where EVIs/EXTSTROBE+ and/or Speedlights are connected.

Note: EXTSTROBE+ must be mounted a minimum of 24 inches (60cm) above the pool deck.

## External Visual Indicator (EVI) and EXTSTROBE+

Any External Visual Indicator or EXTSTROBE+ in the connection sequence can be set to function as a strobe or lane indicator, however only two EVIs or EXTSTROBE+s in the sequence at a time may be set to function as strobes





(see page 21 for details on how to configure an EVI or EXTSTROBE+ as a strobe or a lane indicator).

To connect EVIs or EXTSTROBE+s to the start system, **make sure it is turned off**, then connect up to 13 EVIs or EXTSTROBE+s by daisy chaining them together. Lay the cabling out in a safe and reliable manner and avoid trip hazards. If using an EVI or EXTSTROBE+ as an external strobe, make sure to place it away from the starting blocks. The EVI or EXTSTROBE+ set to function as a strobe is inherently brighter in both low and high intensity settings than lane indicators.

When the starter is powered on, the internal and external visual indicators will go through a red, green, amber, white, white, white pattern to test all LEDs. After this sequence, each EVI and EXTSTROBE+ down the chain will flash white twice. Starts cannot be activated during this brief boot up cycle.

EVI and EXTSTROBE+s can function as either a strobe or as lane indicators. When EVIs and EXTSTROBE+s are set to function as lane indicators they operate at a reduced brightness level and are intended to be placed at the lanes close to the athletes. By default, the visual indicator at the end of the daisy chain will function as a strobe operating at full brightness. For example, if using 9 visual indicators 1-8 will default to lane indicators operating at reduced brightness and 9 will default to function as a strobe at full brightness.

The Championship Elite offers the ability to reconfigure the EVI and EXTSTROBE+ functions from the default settings so that any of the connected EVIs and EXTSTROBE+s can be set to operate as a strobe leaving the remaining EVIs and EXTSTROBE+s functioning as lane indicators. For example, if using 9 EVIs or EXTSTROBE+s 1-4 and 6-9 could be set as lane indicators and 5 could be set to function as a strobe. Please see page 20 for details on how to configure external visual indicators and EXTSTROBE+s.

## Speedlight Connection

For legacy in-deck systems, Speedlights are connected to their appropriate input on the deck plate. Plug the CMP-WPxx cable into the CMP connection on the front of the starter to connect to the in-deck connections for Speedlights.

**Note:** Gen7 in-deck deckplates will power the speedlights by themselves, triggered by the start signal, and do not need a direct connection to the start system.

For on-deck systems, plug the Speedlight connector into the connection on the Speedlight cable harness (Model R-SL-xx) and plug the other end of the harness into the EVI/Speedlight splitter cable (Model R-015-752), which connects to the Championship Elite starter. The Championship Elite starter supports up to twelve (12) speedlights connected using the cable harness.

To use both EVIs and Speedlights in an on-deck system, connect an EVI/Speedlight splitter cable (Model R-015-752) to the starter's External Visual Indicator connection and then connect the EVIs and an R-SL-xx harness to the splitter. The Championship Elite starter will power up to thirteen (13) EVIs and twelve (12) Speedlights simultaneously.

## Start Connection

The start connection is where a start jumper cable (R-INF-SJxx) can be connected from the start input on a deckplate, wall plate, cable harness or directly to the start output banana plugs of a Gen7 timer to integrate the starter into the timing system. Supported timers include: Sys5/6 and, Gen7, as well as some other non-CTS timers that use either a normally open (N.O.) or normally closed (N.C.) start setting. Consult your timer's user manual for compatibility information.

Alternately the Wallplate connection can be used with a CMP-WPxx cable for getting the start signal to a legacy in-deck system and timer.

For serial Gen7 in-deck connections use a starter cable (Model R-015-706-x) to a TDPI-S2 node. Note: This cable also connects the audio signal to the deck.

When a starter is connected, either through the start input on the front panel or the wall plate connector, the starter will show a check mark and "TIMER". It will show "NONE" when no timer is connected.

## Charging Port

The charging port accepts the external power supply to charge the internal batteries. The provided power supply may only be used indoors.

**NOTE: For safety reasons, the Championship Elite Start System cannot be operated while charging.** This keeps AC power away from the pool deck and reduces the possibility of electric shock.

Only use approved DC Supply: 24 VDC @ 2.5A power adapter when charging the unit.

## Microphone Connection

This is where the microphone is connected to the start system. The supplied microphone features a push to talk (PTT) button used to address swimmers and spectators, and two identical "start" buttons for left- and right-handed users to comfortably start the race and recall in the event of a false start.

**Note:** The Championship Elite starter is designed for use with CTS M2-xx and M2-Cxx microphones only. For reliable operation, do not connect any devices other than CTS supplied microphones. Use of legacy CTS microphones such as the M-25 may result in a prominent click when the push-to-talk button is released.

## VSS Connection

The VSS connection is where a VSS-Controller or a VSS-Controller connected together with a PB-6 pushbutton to control the Visual Start Signal sequence is connected. Please see page 11 for details about the functional operation of the VSS system.

## Wallplate Connection

The Wallplate connector is where the starter can be connected to a legacy wall plate with the CMP style connector. The connection contains the start signal, audio signal, speedlight signal and power with control for legacy external strobes. This connection is also used with a starter cable (Model R-015-706-x) to connect to Gen7 in-deck TDPI-S2 nodes. Cover the wallplate connector with the attached dust cover when the connection is not in use.

# Visual Start Signaling (VSS)



The Visual Start Signal (VSS) system provides a clear visual start sequence for all athletes and in particular athletes that are deaf or hard of hearing by utilizing the multi-color LED visual indicator(s) to signal the different segments of the start sequence. Two EVIs/EXTSTROBE+s in the sequence can be set as strobes. EVIs and EXTSTROBE+s set to function as strobes will be brighter and flash white rather than green when a start is initiated.

## Functionality with two officials

The System is controlled by a referee and a starter person. To activate the VSS system connect the 3 button VSS controller for the referee into the VSS connection on the control panel. For the starter, connect a pushbutton (PB-6) into the white banana plug of the VSS controller.

1. The referee calls the event with 4 or more short whistle blasts, twists their hand at chin level and pushes the top button on the VSS controller once. The external visual indicator(s) (EVIs) and EXTSTROBES+ will blink red.  
**Note:** If the referee pushes the button that was last pushed again, it will reset the EVIs and EXTSTROBE+s to blank. For example, the referee could reset the sequence in the event of an unintentional activation.
2. For **forward starts** the referee calls swimmers onto the blocks with one long whistle blast, and signals with their arm over their head and pushes the middle button on the VSS controller. The EVIs and EXTSTROBE+s light steady red.  
For **backstroke starts** the referee calls swimmers into the water with one long whistle blast, signals with their arm over their head, and pushes the middle button on the VSS controller. The EVIs and EXTSTROBE+s light steady red. While the swimmers enter the water the referee drops their arm to the side and pushes the middle button on the VSS controller, the EVIs and EXTSTROBE+s turn off. The referee raises their arm again and pushes the middle button on the VSS controller. The swimmers assume the backstroke start position, the EVIs and EXTSTROBE+s light steady red.
3. The starter official pushes the push to talk button on the microphone, with their arm at shoulder level and pushes their PB-6 pushbutton, then calls "Take your marks". The EVIs and EXTSTROBE+s light up yellow.
4. In the case of an intended "stand up" signal, the starter official holds their arm over their head and pushes their PB-6 button again. The EVIs and EXTSTROBE+s will fade from yellow to the steady red signal. This transition is done slowly so that the athletes do not think a start was initiated and leave the blocks. Once the reason for the "stand up" signal has been rectified, the starter official can repeat point 3 and a transition back to yellow will occur.
5. The starter official pushes the start button while holding the push-to-talk button on the microphone, they move their arm to their side, the EVIs and EXTSTROBE+s set as start strobe(s) flash white and EVIs and EXTSTROBE+s set as lane indicators flash green. Note: the green flash is slightly longer than the white strobe flash to accommodate the potential of an athlete blinking during the start signal and missing the start.

6. The system automatically returns to the reset (blank) state until the referee pushes the top button on the VSS controller to call the next event, starting over at point 1.

## Functionality with one official

The System is controlled by the starter official. To activate the VSS system connect the three button VSS controller to the VSS connection on the control panel.

1. The starter official calls the event with 4 or more short whistle blasts, twists their hand at chin level and pushes the top button on the VSS controller once. The EVIs and EXTSTROBE+s will blink red.  
**Note:** If the starter official pushes the button that was last pushed again it will reset the VSS to blank, for example in the case of an unintentional activation.
2. For **forward starts** the starter official calls swimmers onto the blocks with one long whistle blast, signals with their arm over their head and pushes the middle button on the VSS controller. The EVIs and EXTSTROBE+s light steady red.  
For **backstroke starts** the starter official calls swimmers into the water with one long whistle blast, signals with their arm over their head, and pushes the middle button on the VSS controller. The EVIs and EXTSTROBE+s light steady red. While the swimmers enter the water the starter official drops their arm to their side and pushes the middle button on the VSS controller, the EVIs and EXTSTROBE+s go off. The starter official raises their arm again and pushes the middle button on the VSS controller. The swimmers assume the backstroke start position, the EVIs and EXTSTROBE+s light steady red.
3. The starter official pushes the push to talk button on the microphone, signals with their arm at shoulder level, and pushes the lower button on the VSS controller, then calls "Take your marks". The EVIs and EXTSTROBE+s light up yellow.
4. In the case of an intended "stand up" signal, the starter official holds their arm over their head and pushes the yellow button on the VSS controller. The EVIs and EXTSTROBE+s will fade from yellow to the steady red signal. This transition is done slowly so that the athletes do not leave the blocks thinking a start was initiated. Once the reason for the "stand up" signal has been rectified, the starter official can repeat point 3 and a transition back to yellow will occur.
5. The starter official pushes the start button while holding the push-to-talk button on the microphone, they move their arm to their side, the EVIs and EXTSTROBE+s set as start strobe(s) flash white and EVIs and EXTSTROBE+s set as lane indicators flash green. Note: the green flash is slightly longer than the white strobe flash to accommodate the potential of an athlete blinking during the start signal and missing the start.
6. The system automatically returns to the reset (blank) state until the starter official pushes the top button on the VSS controller to call the next event, starting over at point 1.

**Note:** A starter official can initiate a start sequence with voice and start flash at any time without going through the VSS process. The VSS does not need to be set to any signal.

# Forward Start Signaling Overview

### Call to Block

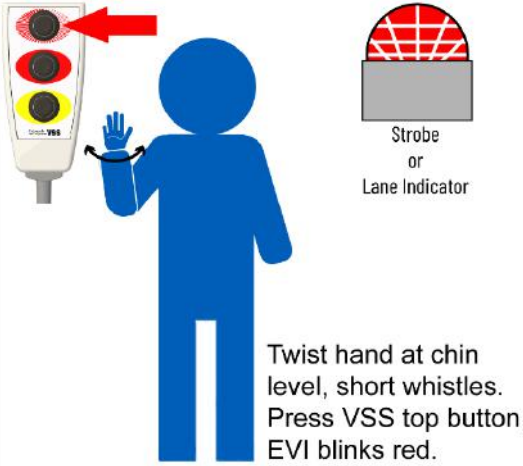

Strobe or Lane Indicator

Twist hand at chin level, short whistles. Press VSS top button, EVI blinks red.

### Step Up

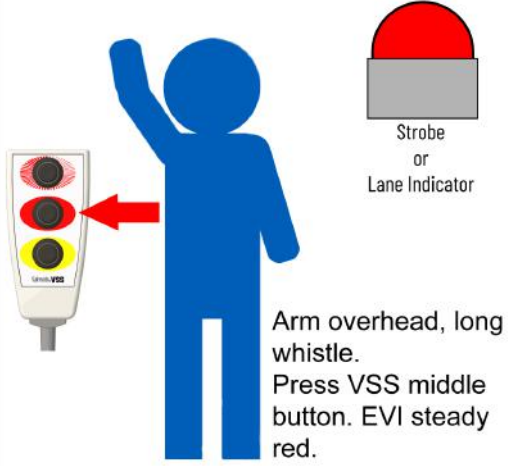

Strobe or Lane Indicator

Arm overhead, long whistle. Press VSS middle button. EVI steady red.

### Take Your Mark

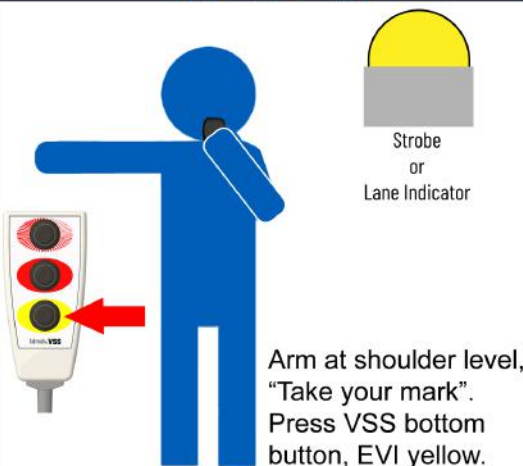

Strobe or Lane Indicator

Arm at shoulder level, "Take your mark". Press VSS bottom button, EVI yellow.

### Start

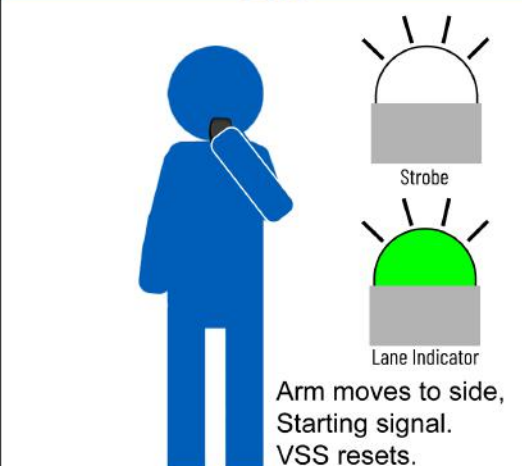

Strobe

Lane Indicator

Arm moves to side, Starting signal. VSS resets.

# Backstroke Start Signaling Overview

**Call to Block**

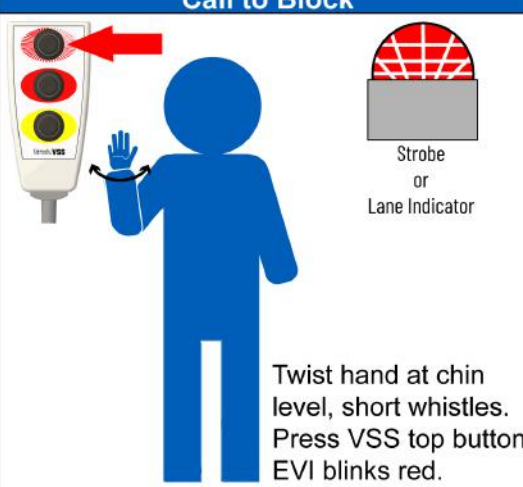

Strobe or Lane Indicator

Twist hand at chin level, short whistles. Press VSS top button, EVI blinks red.

**Swimmers to Enter Water**

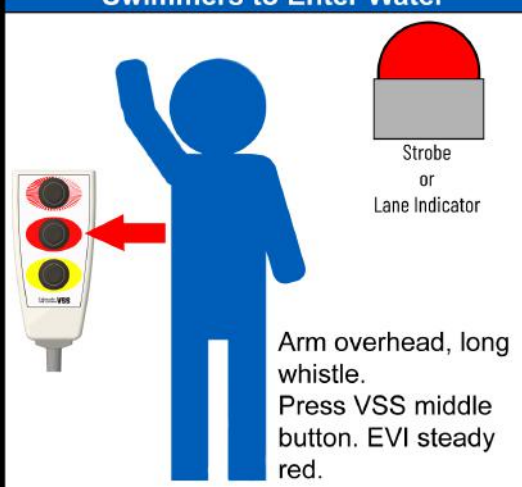

Strobe or Lane Indicator

Arm overhead, long whistle. Press VSS middle button. EVI steady red.

**Swimmers Enter Water**

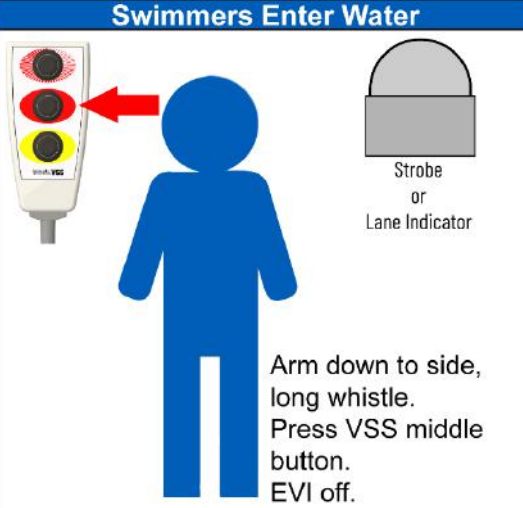

Strobe or Lane Indicator

Arm down to side, long whistle. Press VSS middle button. EVI off.

**Backstroke Start Position**

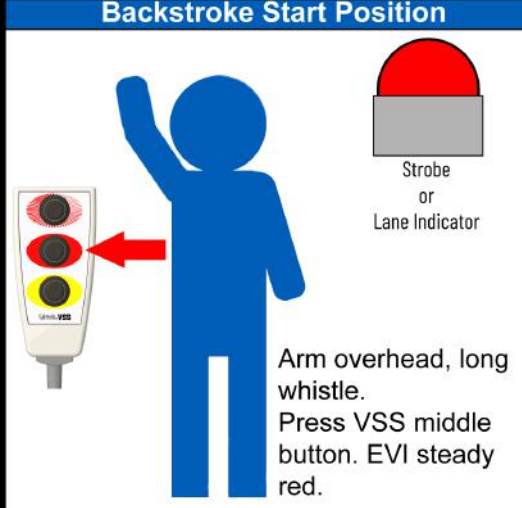

Strobe or Lane Indicator

Arm overhead, long whistle. Press VSS middle button. EVI steady red.

**Take Your Mark**

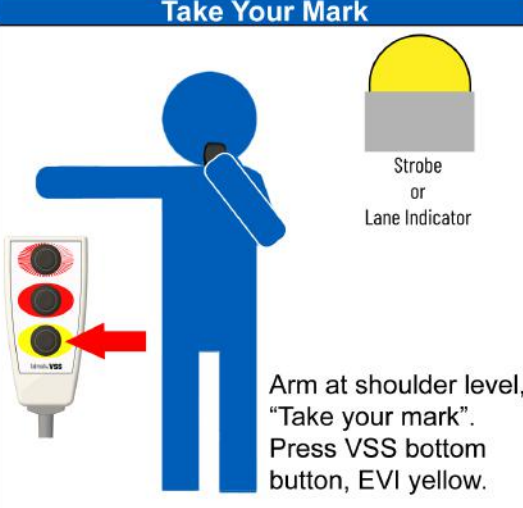

Strobe or Lane Indicator

Arm at shoulder level, "Take your mark". Press VSS bottom button, EVI yellow.

**Start**

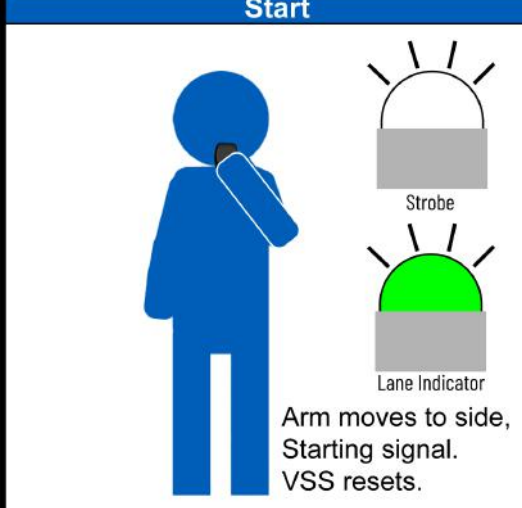

Strobe  
Lane Indicator

Arm moves to side, Starting signal. VSS resets.

# Operation

## Main Screen



## Navigation

Use the up and down arrows to highlight the different options and use the left and right arrows to adjust customizable selections.

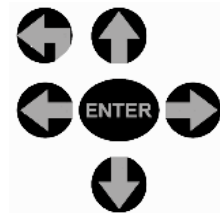

### 1: Internal Speaker Volume

Select "Int. Spkr" with the up or down navigation arrow. Once highlighted adjust the volume of the internal speaker volume up or down using the left and right navigation arrows.

### 2: Start Volume

Highlight "Start Vol" using the up or down navigation arrow. Use the left and right navigation arrows to set the volume of the start tone to either Low, Medium, or High.

### 3: Lane Speaker Volume

Use the up or down navigation arrow to highlight "Lane Spkr", then use the left and right navigation arrows to adjust the external lane speaker(s) volume up or down.

### 4: Mic Status

The Mic Status section of the screen shows the connection status of the microphone. It will display ✓ when a microphone is properly connected or ⊘ if no microphone is connected or if there is a problem with the connection.

### 5: VSS and Recall Status

When VSS is active, each phase of the VSS process will be shown here. "Call For Race", "Step Up", "Take Your Marks" and a Recall Active countdown will be displayed as each phase is triggered by the operator(s).

### 6: Battery Level Indicator

The battery level indicator shows the current level of the battery. The indicator will display battery level in 20% segments however the percentage of charge readout will display 10% segments.

### 7: Timer Section

The timer section shows the current connection status to a timer. "TIMER" will be displayed when a timer connection is detected for both the start output (S) and wall plate (W) connections. "NONE" is displayed when no timer connection is detected for either the start output or wall plate connections.

## Battery

The Championship Elite start system operates on a built-in 12 VDC power source. When the two batteries are fully charged, typical operation is more than 15 hours, depending on usage. Using the microphone as a public address system and using VSS substantially reduces battery life.

It is important to make sure the batteries are fully charged before each day's use. Pay attention to the battery life indicator and recharge the batteries after each use.

To recharge the internal batteries, power the unit off, move the Championship Elite from the pool area to indoors, plug the battery charger into a grounded outlet, and attach the cable from the battery charger to the charger connector on the Championship Elite starter control panel. The device will boot up and begin charging. It automatically detects the battery state and switches from power charging to maintenance charging. Keep the charger plugged in until the next use.

The charging circuit in the Championship Elite starter prevents overcharging, allowing it to stay plugged in for extended periods of time while keeping the batteries in a fresh, fully charged state.

Should the batteries deteriorate, the charger will detect the deterioration and go into a slow charge mode and try to restore the batteries in several tries. If the batteries cannot be restored, a warning to change the batteries will be issued by the LED blinking red and the display presenting a text.

**Note:** Do not change the internal batteries outdoors or near water. Bring the unit to a dry, safe location before removing internal batteries.

## Championship Elite and Electronic Timer

If using the Championship Elite with an electronic sports timer, connect the timer start cable (R-INF-SJxx) from the start input of a deckplate or cable harness or from the back of a Gen7 timer to the Start input on your Championship Elite control panel.

Alternately you can either connect the start system through the Wallplate CMP connector to a legacy in-deck system where the start signal is carried through the CMP cable (CMP-WPxx), or use a Gen7 starter cable (Model R-015-706-xx) to connect to a Gen7 in-deck system through a TDPI-S2 node. The speaker signal and start signal is carried through the starter cable.

The Championship Elite can generate Normally Open (N.O.) and Normally Closed (N.C) start pulses. N.O. works with all Colorado Time Systems' electronic timers. If your timer requires a Normally Closed start pulse, see Settings on page 19 for information on changing the start pulse type.

**CAUTION:** When the start signal polarity is set incorrectly for a specific timer, the race times of the athletes will not be accurate.

When the starter is set to Normally Open (N.O.) and a timer is connected, the starter will automatically detect it and display "TIMER" on the main screen for either the Start connector or the Wallplate connector. "NONE" is displayed if no timer is detected.



## Starter's Microphone

To use the starter's microphone for public address, press the push-to-talk switch located on the top left side of the microphone and speak into the grille on the front of the microphone. To start a race, hold down the push-to-talk switch and press one of the two start buttons on the top of the microphone. Either of the two start buttons can be used to activate the start signal. Use the button most convenient for using the microphone with either the left or right hand.

To recall a false start, press the start button a second time after a start while holding the push-to-talk button. The recall must be made within the set recall period of the start pulse. See page 20 for details about setting the duration of the recall period.

Two convenient microphone rests are built into the Championship Elite to the left and right of the control panel. When the microphone is not in use, snap the microphone onto one of the rests. Either microphone rest can be removed and replaced with either a VSS controller holder or a Dolphin adapter.

## Optimize Microphone Operation

There are a few simple steps that can be taken to optimize the quality of the audio and prevent feedback when using the starter microphone.

- Hold the microphone very close to the mouth and make sure to speak normally or loud into the microphone.
- Stay away from the horn speaker in the front of the starter. The speaker is where the sound for feedback comes from.
- Start with the internal speaker volume set low and increase as needed to cut through the ambient noise.
- Use microphone tone controls available with the Championship Elite to fine tune voice amplification to be understood clearly, cut through ambient noise, and reduce feedback potential. For details about setting the microphone tone, see Audio Setting on page 19.

## Training Mode



Using the Championship Elite start system during training sessions is one of its most useful features. Swimmers will quickly become accustomed to electronic starting and will thereby improve their start reflexes.



Once the training mode is activated by selecting it in the menu and pressing enter, the starter will count down and a recorded "Take your marks" message will be played. After an arbitrary time a start tone and strobe flash will be executed. The arbitrary time span length is between 1.5 and 2.5 seconds to prevent athletes from pacing themselves on the "take your marks" signal and train to always start triggered by the start tone and strobe.

After a settable wait time (5 to 45 seconds without VSS or 15 to 45 seconds with VSS) the next "take your marks" and tone/strobe are presented to the next athlete, and so forth.

The Visual Start System can be used at the same time by checking the checkmark in the menu. Note: battery consumption will increase if using VSS with Training Mode.

To exit training mode, press the  button. Then press the  button two more times to return to the main screen.

**Note:** during training mode start pulses are not generated.

## Strobe Usages: Internal and EVIs/EXTSTROBE+s

The internal strobe and connected EVIs and EXTSTROBE+s flash (lane indicator: green or strobe: white) automatically whenever the start system generates a start pulse and start tone. If officials, parents, and spectators attempt to start their stopwatches from the start tone, they will not get accurate starts. The relatively slow speed of sound (compared with the speed of light) generally results in late stopwatch starts for observers at any distance from the speakers.

Educate officials, parents, and spectators to use the strobe flash to start their stopwatch. The strobe flash is unaffected by poor acoustics and the fast speed of light ensures that all observers see the flash at the same time, resulting in more accurate stopwatch starts. The strobe also ensures fair starts for athletes that are deaf or hard of hearing.

When using EXTSTROBE+ they must be mounted a minimum of 24 inches (60cm) above the pool deck.

Please see page 8 for information on connecting EVIs/EXTSTROBE+s

# Settings

The Championship Elite start system offers a variety of settings to customize the experience for each environment.



## Navigation

To enter the main menu, press the enter button located in the center of the navigation arrows. Once in the main menu, use the navigation arrows to move through the different options and press enter to select.

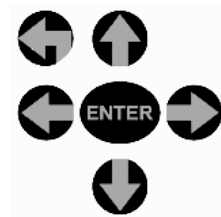

The back arrow  will move back to previous menu levels or return to the main screen from the main menu.

## Main Menu

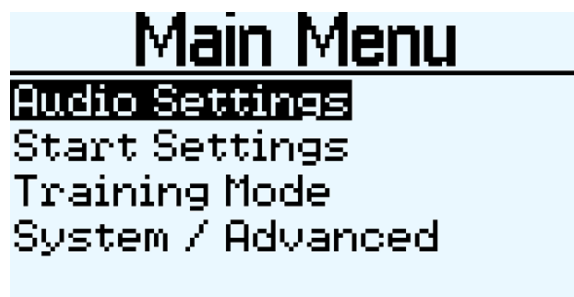

In the Main Menu there are four sub menus. Audio Settings, Start Settings, Training Mode, and System / Advanced.

## Audio Settings



In the Audio Settings menu, the volume of the microphone through the internal speaker and external lane speaker(s) can be adjusted up or down by choosing “Int. Spkr” or “Lane Spkr” with the up and down arrows.

Choose the Tone control for the Wired Mic with the up and down arrows to dial in the clearest possible audio signal for each environment. “B” indicates a more bass laden audio signal, “T” more treble.

To adjust volumes or tone, highlight the desired option and use the right and left navigation arrows to adjust the parameter up or down. If a speaker’s volume is turned all the way down (muted), neither the mic nor the start tone will sound through the muted speaker(s). If not muted, the start tone will sound at the volume set in race settings (page 20).

## Start Settings

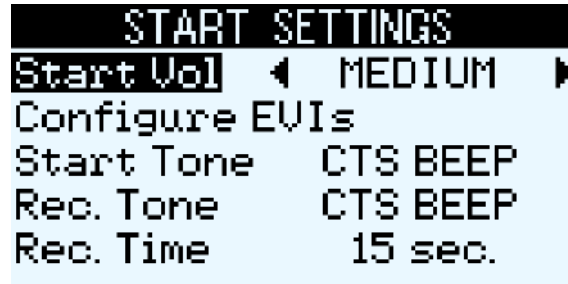

### Start Volume

The Start volume is separate from the microphone volumes set in Audio settings or on the main screen. Choose between High, Medium, or Low for outdoors, indoors and in office environments.

**Note:** High volume is greater than 120dB and should only be used in outdoor environments to avoid potential hearing damage.

### Configure EVIs

Configure EVIs opens the Configuration menu for External Visual Indicators and EXTSTROBE+s. See page 21 for details on configuring the EVIs and EXTSTROBE+s.

Note: The Configure EVIs option only becomes available in the Start Settings menu when EVIs have been connected before powering on the start system. If no EVIs or EXTSTROBE+s are connected to the start system, or if EVIs or EXTSTROBE+s were connected while the start system is powered on, the Configure EVIs menu will not be visible.

### Start Tone

Choose between the classic CTS beep or an alternate beep that is shorter.

### Recall Tone

Select the tone that is sounded for a false start recall. Select between the classic CTS beep or a shorter alternate beep.

### Recall Time

Set the amount of time after a start that a false-start recall is active; it can be between 5 and 25 seconds.

## EVI and EXTSTROBE+ Configuration



External Visual Indicator (EVI) and EXTSTROBE+ settings is accessed via the Start Settings menu. See page 20 for details. **Note:** This option is only available when EVIs or EXTSTROBE+s have been connected before powering on the Elite Starter.

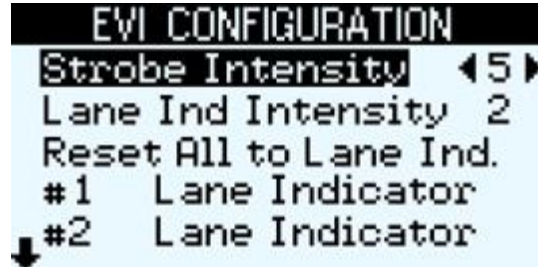

### Strobe Intensity

Set the intensity of all connected EVIs and EXTSTROBE+s set as strobes with the left and right arrows between 1 (low) and high (8). (0) turns the strobe off.

### Lane Indicator Intensity

Set the intensity of all connected EVIs and EXTSTROBE+s functioning as lane indicators with the left and right arrows between 1 (low) and high (8). (0) turns the lane indicators off.

### Reset All to Lane Indicators

Resets all external strobes to be lane indicators. See page 8 for External Visual Indicator functions and placement.

### #1 through #13

Here each EVI and EXTSTROBE+ can be set to function as a lane indicator, a strobe, or be set to off. External visual indicators and EXTSTROBE+s are listed in the order that they are connected along the daisy chain with #1 being the external visual indicator or EXTSTROBE+ connected directly to the starter.

Two of the up to 13 EVIs or EXTSTROBE+s can be set to function as strobes which are inherently brighter in both low and high intensity settings than lane indicators. Any EVI or EXTSTROBE+ in the daisy chain can be turned off. If an EVI or EXTSTROBE+ is set to off, it will ignore any VSS and strobe signals.

When setting the function of an external visual indicator or EXTSTROBE+ it lights up to show which function it is set to. When set as a lane indicator the LEDs will light up green. When set as a strobe it will show white. When set to off, it will light up red.

## Training Mode Settings

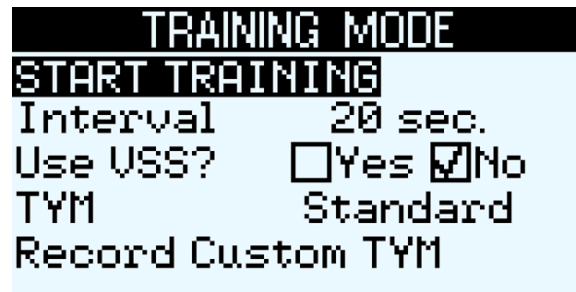

### Start Training

Highlight Start Training with the up and down arrows and press enter to engage training mode. The device will display countdown and signals being relayed to athletes as well as the volume sliders to adjust the audio volume during training.

To exit Training mode, use the back arrow  to end and navigate back to the main menu.

### Interval setting

Adjust Interval to set the time between the previous start and the next “Take your marks” command. When operating without VSS the interval between each “Take your marks” command can be set at 5 second increments between 5 and 45 seconds. When operating using VSS the interval can be set at 5 second increments between 15 and 45 seconds. See page 17 for details about training mode.

### Use VSS

To use VSS while in Training Mode, highlight the **Yes** check box and press enter. To disable VSS while using Training Mode, highlight the **No** checkbox and press enter.

**Note:** Using VSS while in Training Mode will increase battery consumption.

### TYM (Take Your Marks)

Select between the default “take your marks” recording or a custom “take your marks” recording.

If no custom “take your marks” has been recorded, this option will not be visible.

### Record Custom TYM

Select to record a custom “take your marks” to be played as part of the start sequence while in training mode. Once selected, wait until RECORD is displayed on the screen, then hold down the push-to-talk button and speak into the microphone. Release the push-to-talk button to save the custom recording to internal memory. The recording will be played back immediately after releasing the push-to-talk button. The custom recording can be up to two seconds long.

## System/Advanced Settings

```
SYSTEM/ADVANCED v1.3.8
Auto Off      ◀ 60 min. ▶
BKLT Bright   LOW
BKLT Time     5 sec.
Advanced Options
Serial #:     202112501
```

### Auto Off

Set the amount of time the starter will stay powered on without an input. The time interval will be reset when any input is received. If the time interval expires the device will shut down to preserve battery charge.

The time interval can be set at either 30, 60 or 90 minutes.

### Backlight Brightness

Select the brightness level of the LCD screen backlight. Set to either low, medium, or high.

### Backlight Time

Set the duration of time the backlight will remain on after a menu keypress. It can be set to 5, 15, or 30 seconds, or set to always on.

### Advanced Options

Selecting Advanced Options will open the Advanced menu where the internal strobe intensity and Start Signal polarity can be adjusted, and where the system can be restored to factory defaults. See Page 24 for details.

### Serial Number

Displays the unit's serial number.

## Advanced Options

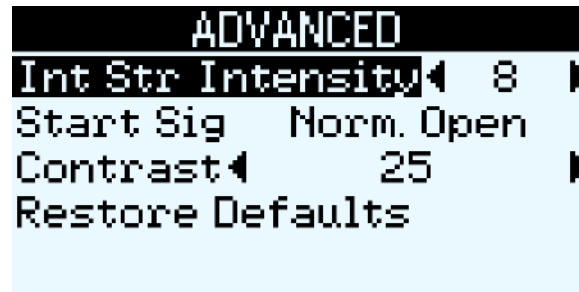

### Internal Strobe Intensity

Set the internal strobe intensity independent of the intensity set for EVIs and EXTSTROBE+s functioning as strobes. Set the internal strobe intensity to SYNC to have the internal strobe automatically adjust to the strobe intensity set for EVIs and EXTSTROBE+s in the EVI Configuration menu (Page 21).

### Start Signal Polarity

Select either a normally open (N.O.) or normally closed (N.C.) signal. N.O. signal is used for CTS and Daktronics systems and N.C. is used for Swiss Timing systems. While toggling between the two signal types, the start signal may trigger the timer if it is connected.

**CAUTION:** When the start signal polarity is set incorrectly for a specific timer, the race times of the athletes will be started incorrectly and will be not accurate by tenths of seconds.

The starter will show a status of the N.C. signal when turned on to alert the user.

### Contrast

Adjusts the contrast of the LCD screen between 0 and 60. The contrast is set to its optimum viewing clarity at the factory and should only be adjusted based on specific facility and user requirements.

### Restore Defaults

When highlighted, press Enter to restore all settings to factory defaults. A confirmation message will appear on the screen. Press Enter to continue restoring factory defaults or

press the  button to abandon the default setting restoration and return to the Advanced Options menu.

**CAUTION:** this action will override all manually adjusted settings.

Please see Appendix B on Page 32 for list of all factory default settings.



## Maintenance



Your Championship Elite start system has been carefully designed to provide years of trouble-free service. No routine maintenance is necessary but following a few simple preventative care steps will ensure that your Championship Elite continues to function at its optimum level.

Scan or click the QR code to open the CTS Maintenance Checklist for information on standard maintenance for CTS equipment.

### Batteries

The usable life of the internal batteries can be extended by always keeping it fully charged and never allowing it to discharge completely. Leave the Championship Elite plugged in when not in use. The intelligent charging system will keep the batteries in a fresh and fully charged state.

### Storage

It is best to store the Championship Elite starter in a cool, dry place after each use. Do not store the unit in an area that becomes overly humid, hot, or cold. Try to keep it in a dry location that remains around 70-80 degrees Fahrenheit throughout the year.

Leave the Championship Elite plugged in when not in use. The intelligent charging system will keep the batteries in a fresh and fully charged state.

## Configuration Diagrams:

The following diagrams illustrate typical configurations for integrating your Championship Elite start system with existing CTS equipment.

### Connection to Legacy Wallplate:

Connect a CMP-WPxx cable from the Start System output of the legacy wallplate to the WALLPLATE connector on the Elite Stater.

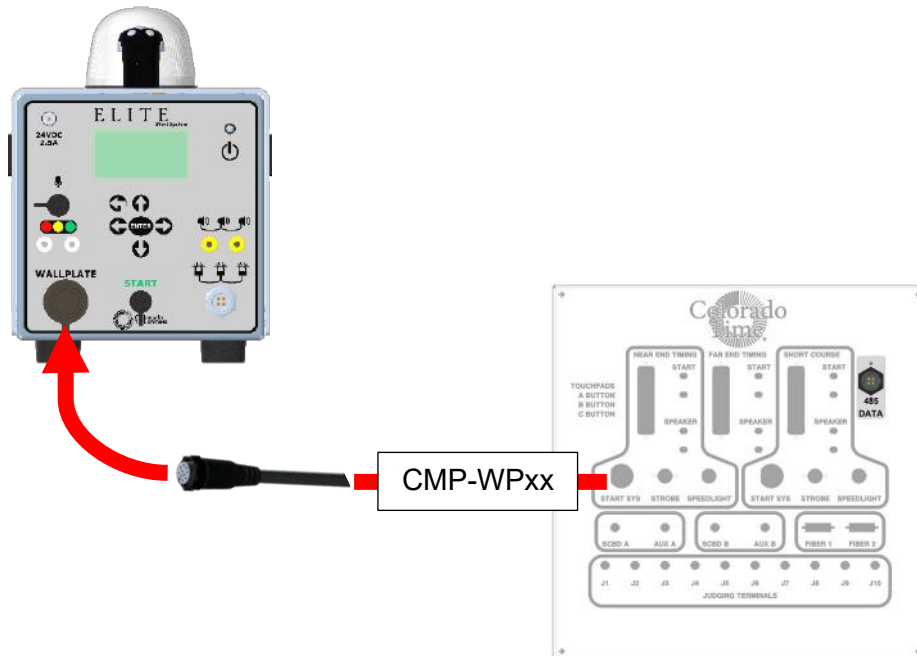

### Connection to Gen7 In-Deck or Wallplate:

Connect an R-015-706-xx cable (8 or 15 meters) from the WALLPLATE connector on the Championship Elite starter to the TDPI-S2 (In-Deck) or WPI-S2 (Wallplate) Starter connect node.

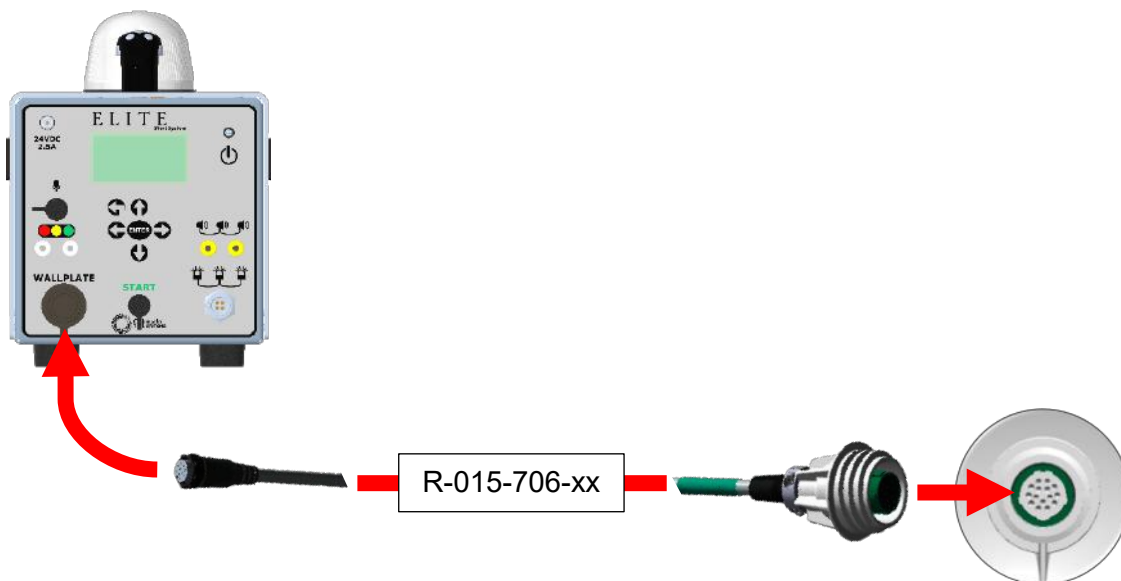

### Connection to Deckplate, Cable harness, or Timer:

Connect the banana jack end of an INF-SJ-xx cable to the start input on the Deckplate, Cable harness, or Timer, and connect the end with the 1/4in jack to the Start input on the Championship Elite Starter.

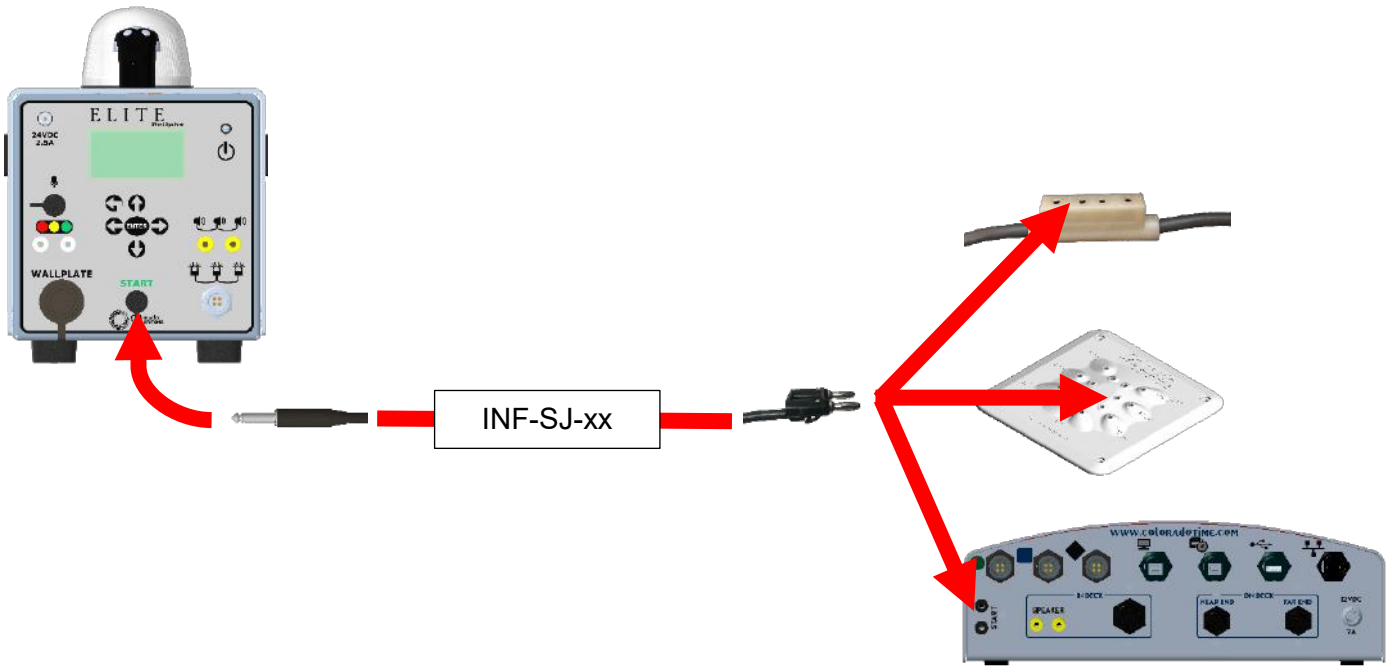

# Troubleshooting

Symptom	Action
Nothing Works.	<ol style="list-style-type: none"> <li>1. Turn unit on by pressing the power button until it is on. If the LED indicator is red or the unit powers itself down immediately, the battery is discharged.</li> <li>2. Check all connections on Championship Elite control panel.</li> </ol>
Battery will not charge	<ol style="list-style-type: none"> <li>1. Check power AC outlet—use a working lamp to check for power at outlet.</li> <li>2. Check charger connection on the Championship Elite control panel.</li> <li>3. Replace batteries.</li> </ol>
During charging the LCD is blank	<p>There was an issue initializing the LCD screen. Charging continues and preserves the battery. The LED shows the fast charge and maintenance charge pattern:</p> <ol style="list-style-type: none"> <li>1. Unplug and plug the unit back in. If the problem persists, please contact Customer Service.</li> </ol> <p>Unplug the unit and turn it on. If the LCD stays blank and the LED is blinking fast red, contact Customer Service.</p>
After approximately 8 hours of Fast charging, the unit goes into Maintenance charging and the status LED blinks yellow	The battery health is degraded. Most likely the batteries are able to provide power for some meets, but battery replacement is recommended.
When powered on, the LCD screen is blank, and the status LED is blinking fast red.	There was an issue initializing the LCD screen. Power cycle the unit. If the problem persists, please contact Customer Service.
Experiencing Feedback.	See page 17 for microphone optimization tips.
Some speakers work, others do not.	Check speaker connector(s) on cable harness or deckplate.
EVI/EXTSTROBE+ flashes green instead of white when set as an external strobe.	If the EVI/EXTSTROBE+ is connected to the starter after the starter was powered on, it will only flash GREEN when a start is initiated. Turn unit off, wait 10 seconds, and back on to allow EVI/EXTSTROBE+ to be activated as an external white strobe. See page 8 for EVI/EXTSTROBE+ connection details.
Intermittent VSS functionality. White/Green start signal flashes operate correctly.	<p>EVI/EXTSTROBE+s have safety mechanisms that shut off the LEDs when the internal temperature limit of the LEDs is exceeded. Although rare, this can occur in high-temperature outdoor environments. Once the EVI/EXTSTROBE+ is cooled down the LEDs will automatically turn on again. Start signal flashes are not affected.</p> <ol style="list-style-type: none"> <li>1. Wait to use VSS function until unit has cooled.</li> <li>2. Discontinue use of VSS</li> <li>3. Place EVI/EXTSTROBE+ in shade of starting block or other shade providing structure to keep it cooler.</li> </ol>

<p>External speaker(s) stop working.</p>	<p>As a rule, the speaker connection should not be in standing water. The connections can be wet but being in standing water or very wet and close to other cable harnesses can trigger an audio safety fault.</p> <p><u>Cable harness set up:</u></p> <ol style="list-style-type: none"> <li>1. Make sure neither the CMP cable nor the speaker harness are connected to the starter and check if the fault persists. <ol style="list-style-type: none"> <li>1a. If the fault persists without speaker harness and CMP cable connected, the fault is inside the starter. Contact customer support to send the unit to CTS for repairs.</li> </ol> </li> <li>2. If the fault does not persist after disconnecting the speaker harness, reattach the speaker harness and go down the speaker harness moving connections and unplugging speakers until the cause of the fault is found and corrected.</li> </ol> <p><u>CMP Cable Setup:</u></p> <ol style="list-style-type: none"> <li>1. Make sure neither the CMP cable nor the speaker harness are not connected to the starter and check if the fault persists. <ol style="list-style-type: none"> <li>1a. If the fault persists without the speaker harness and CMP cable connected, the fault is inside the starter. Contact customer support to send the unit to CTS for repairs.</li> </ol> </li> <li>2. If the fault does not persist, connect the CMP cable to the starter and make sure it is unplugged from the wallplate. <ol style="list-style-type: none"> <li>2a. If the fault persists, the CMP cable may have a short. Replace CMP cable.</li> </ol> </li> <li>3. If the fault does not persist with the CMP cable unplugged from the wallplate, connect CMP cable to the wallplate then go down the row of speakers unplugging them one by one to check if the fault persists. <ol style="list-style-type: none"> <li>3a. If the fault persists without speakers plugged in, there may be a short in the in-deck cabling. Contact customer support for service.</li> </ol> </li> </ol>
<p>Main screen displays “Wet” in timer section.</p>	<p>Starts can still be issued correctly but it is advisable to check start connections for excessive moisture. Move start connection to drier location.</p>
<p>Main screen displays “Wet Wet” warning.</p>	<p>In this state excessive moisture is present around the start connections (i.e., it is submerged in standing water). This state can cause erroneous starts when the mic is keyed (PTT pushed). Move start connection to drier location.</p> <p>Warning screen will persist while the condition exists. Main screen will return once the connection is drier.</p>

If the problem you are experiencing is not mentioned in the Troubleshooting guide or the recommended steps do not solve the problem, contact Customer Support toll-free at 800-287-0653 (U.S. and Canada) or 970-667-1000 for assistance or email [support@coloradotime.com](mailto:support@coloradotime.com)

# Specifications

## General

Model SSE: Loudspeaker Start System consisting of a start module with built-in multi-color LED visual indicator, built-in 40-watt corrosion-resistant speaker, two (2) internal 12V gel-cell lead acid batteries, external indoor battery charger power supply, one plug-in microphone, and instruction guide.

## Physical

Height: 6.5 inches

Length: 14 inches

Width: 6.5 inches

Weight: 19.6 lbs (8.9 kg)

## Environmental

Temperature: 0°C - 45°C Humidity: 90% (non-condensing) Altitude: 0 to 3000 m

## Electrical

Power adapter DC Supply: 24 VDC @ 2.5A. The 24 V power adapter is used for recharging indoors only.

**Note:** The Championship Elite Start System can only be operated from battery power, keeping AC power away from the pool deck and reducing the possibility of electric shock.

## Battery

Type: Two 12 V Gel Cell Lead Acid, PowerSonic PS-1270 only, 12V 7.0 Amp hour.

Operating Time: More than 15 hours of normal use without EVIs/EXTROBE+s or VSS

Recharge Time: about 2.5 hours

## Fuses

For batteries – Two 10A Time Lag, 5mm x 20mm on the printed circuit board

## Input and Output Connections

Microphone Port: Input

VSS Port: Input

External Charging Power: Input - 24 VDC @ 2.5A

Speaker Port: Output – max 75W @ 4 Ohms.

Lane speakers: Max. 12 CTS approved lane speakers or two underwater speakers.

Start Port: Polarity independent start signal and communication to Gen7.

Wallplate connection for speaker, start signal, external legacy strobe.

Strobe/Speedlight connection for up to 13 EVIs/EXTSTROBE+s and up to 12 speedlights.

Programmable functions: start normally open/normally closed polarity. Audio start beep volume loud for outdoor, medium for indoor, low for office use. Strobe and lane indicator intensities in 8 intensity levels, and off.

## Appendix A: Certifications

### Safety Certification

This device conforms to Std. UL 863 and UL 1492 and is listed in Colorado Time Systems' UL file E190097.



### FCC Information

#### FCC Compliance Statement

This device complies with Part 15 of the FCC Rules. Operation is subject to the following two conditions:

- 1) This device may not cause harmful interference.
- 2) This device must accept any interference received, including interference that may cause undesired operation.

Unauthorized modifications or changes made to this device not expressly approved by the party responsible for compliance voids the user's authority to operate the equipment.





EUROPEAN DECLARATION OF CONFORMITY

We,

Everlast Climbing Industries, Inc.  
DBA Colorado Time Systems  
1551 E 11<sup>th</sup> Street  
Loveland, CO 80537, USA  
++1 970 667 1000  
[www.coloradotime.com](http://www.coloradotime.com)

declare under our sole responsibility that the

Product: Start System  
Model numbers: Elite, SSE

to which this declaration relates is in conformity with the following European Directives:

European Council Directive 2001/95/EC, 2014/35/EU, 2014/53/EU  
Safety of electronic equipment within the fields of Audio/Video, Information  
Technology and Communication Technology

CENELEC EN 62368-1:2020/A11:2020 Issued 2020/01/06

European Council Directive 2014/30/EU (26 February 2014) on Electromagnetic  
Compatibility.  
EN 61326-1:2013, EN 55011:2016

European Council Directive 2011/65/EU (July 21, 2011) and Commission Delegated  
Directive (EU) 2015/863. of 31 March 2015 on the Reduction of Hazardous Substances  
(RoHS).

The Technical Construction File is maintained at the corporate headquarters of Colorado  
Time Systems in Colorado, USA.

Date of issue: January 19, 2024  
Place of issue: Loveland, Colorado, USA

  
Michael Medina-Brodsky  
Director of Operations



## Appendix B: Factory Default Settings

<b>Start Settings</b>	
Start Volume	Medium
Strobe Intensity	8
Start Tone	CTS Beep
Recall Tone	CTS Beep
Recall Time	15 Seconds

<b>Training Mode Settings</b>	
Interval	15 Seconds
VSS	No
TYM (Take Your Marks)	Standard

<b>Audio Settings</b>	
Internal Speaker Volume	Middle position
Lane Speaker Volume	Middle position
Wire Mic Tone	Middle position

<b>System/Advanced Settings</b>	
Auto Off	60 Minutes
Backlight Brightness	High
Backlight Time	30 Seconds

<b>Advanced Options</b>	
Internal Strobe Intensity	Sync
Start Signal Polarity	Normally Open
Contrast	25

## Appendix C: Supporting & Auxiliary Equipment

<p><b>TR-3</b> CTS Tripod</p> 	<p><b>EVI and EXTSTROBE+</b> External Visual Indicator</p> 
<p><b>START-FPM-2</b> Pole mount kit for CTS starters.</p> 	<p><b>R-015-747-xxx</b> EVI/EXTSTROBE+ Connection cable available in lengths of 15ft, 125ft, 10m, or 50m.</p> 
<p><b>EVI-FPM</b> Pole mount kit for EVIs/EXTSTROBE+s</p> 	<p><b>R-015-752</b> Elite Start System Y-splitter to legacy Speedlights and EVIs/EXTSTROBE+s</p> 
<p><b>R-015-755</b> Elite Start System to Legacy speedlight adapter</p> 	<p><b>R-INF-SJxxx</b> Start Jumper Cable: SSE to Timer/Deckplate</p> 
<p><b>R-420-003</b> Replacement Battery</p> 	<p><b>R-920-061</b> Replacement power supply Available power cords: R-015-367 type A US- 6ft R-015-369 type F EU- 6ft R-015-379 type G UK- 6ft R-015-380 type I AU/CHN- 6ft</p> 



Customer Service Department  
[www.coloradotime.com](http://www.coloradotime.com)  
Email: [support@coloradotime.com](mailto:support@coloradotime.com)  
Phone: +1 970-667-1000  
Toll Free U.S. and Canada 1 800-287-0653  
Fax: +1 970-667-1032